



# KEEP YOUR COSTS IN LINE

with *smartDESIGNER*, *smartSCRIPT*, and *smartPRINTER*





## Contents

<b>smartDESIGNER ONLINE</b> Concept - Research - Design - Build	4
<b>SAVE MONEY WITH smartPRINTER</b> Cost-Effective Marking, Easy to Use, Universal, Easy Installation	6
<b>CLEARLY MARK CONTROL CABINETS</b> Terminal Block Marking, Cable and Conductor Marking, Device Marking	7
<b>TERMINAL BLOCK MARKING</b> Marking Strips, WMB Markers on a Roll	8 – 9
<b>SELECTION MATRIX</b> Marking Accessories and Appropriate Product Series	10 – 11
<b>CABLE AND CONDUCTOR MARKING</b> Marking Sleeves and Markers, Cable Tie Markers, Conductor Markers for Thread-On Mounting, Self-Laminating labels, Shrink Tubing	12 – 13
<b>DEVICE MARKING</b> Self-Adhesive Continuous Labels, Self-Adhesive Marking Strips, Self-Adhesive Polyester Labels, Fabric Labels, Push-Button Markers, Type Plates, Void/Temper-Proof Label	14 – 15

# smartDESIGNER Online

## configurator.wago.com

The new *smartDESIGNER* online runs exclusively on a cloud server ensuring that users will always have the most up-to-date version of the program. As a result, new WAGO components are available for use without needing a software update. The *smartDESIGNER* allows for the seamless progression of a project through planning, documenting, building, and labeling.

### CONCEPT



#### Benefits:

- No installation
- No updating
- Accessible anywhere
- Newest WAGO components available immediately
- Free

### RESEARCH



- Product catalog allows you to find the WAGO product to fit your needs
- Easy to find technical data and component specifications
- Customizable libraries for sorting commonly used components
- Add your own part numbers that follow parts through the design process

### DESIGN

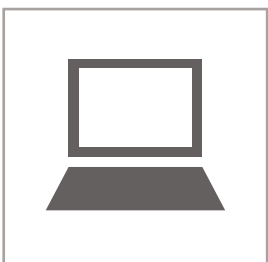

- Create your assembly exactly the way you want it
- Program shows viable accessories that work with components in the project
- Generate parts list with product images
- Add custom labels that can be sent directly to a WAGO *smartPRINTER*
- Program checks your design for safety and functional build errors

### BUILD

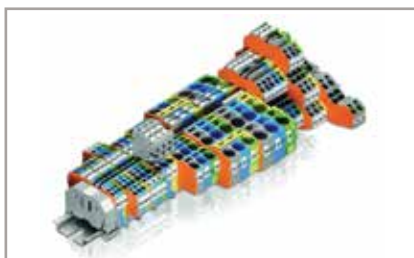
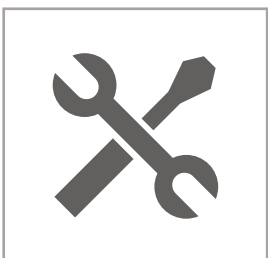

- Customizable project print out with multiple views and information
- Immediately print labels using WAGO *smartPRINTER*
- Export projects in numerous CAD formats for further panel design
- Send project directly to WAGO to build

## CAD EXPORT



- *smartDESIGNER* can export your project as a detailed CAD drawing ready to be inserted into further project designs
- Program generates 2D and 3D models
- Exports in commonly used neutral and proprietary CAD formats such as STEP, IGES, DXF, DWG, Inventor, NX, and SolidWorks Visual Basic files

## CAE INTERFACES

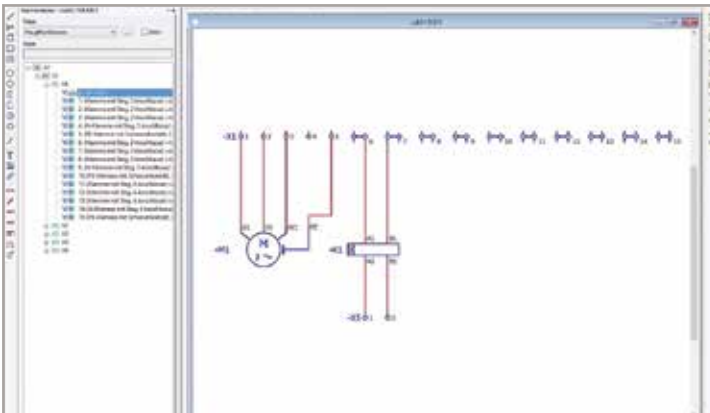

- Various interfaces for electrical design programs such as EPLAN and WSCAD are available
- Projects can be exported from your design software directly into *smartDESIGNER* to check for build errors, and then reimported back into your original program
- WAGO labels can then be printed from the electrical design program right to the WAGO *smartPRINTER*

## LABELING WITH *smartSCRIPT*

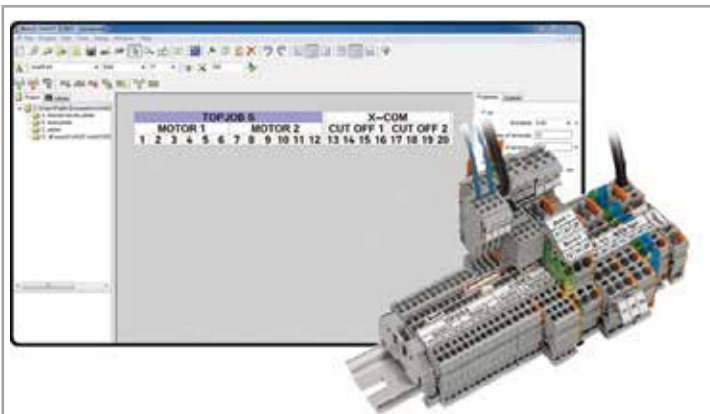

- *smartSCRIPT* is a locally installed labeling program that can be used without an internet connection
- Seamlessly export labels created in *smartDESIGNER* Online directly into *smartSCRIPT*
- Create labels using the full range of WAGO marking products
- Direct output to the WAGO *smartPRINTER*

# SAVE MONEY WITH *smart*PRINTER

## Universal Marking Solution

### Cost-Effective Marking

- Industry's most affordable printing solution
- Lower material costs
- Reduce marking time
- Minimal maintenance

### Easy to Use

- Generate all marking data directly via *smart*SCRIPT marking software

### Universal

- For any control cabinet marking application
- Mark all WAGO terminal blocks and label conductors/cables and devices

### Easy Installation

- Installation package and marking software are available at: [www.wago.com/smartprinter](http://www.wago.com/smartprinter)



*smart*PRINTER  
Item No. 258-5000

Long-Lasting, Wipe- and  
Scratch-Proof Marking

### Accessories



258-5030\* Cutter Attachment  
for *smart*PRINTER



Carrying case for *smart*PRINTER  
Item No. 258-5015  
Dimensions (cm):  
50 W x 26 H x 33 D



Ink ribbon, standard  
Item No. 258-5005



Ink ribbon for self-laminating  
labels and heat shrink  
Item No. 258-5014

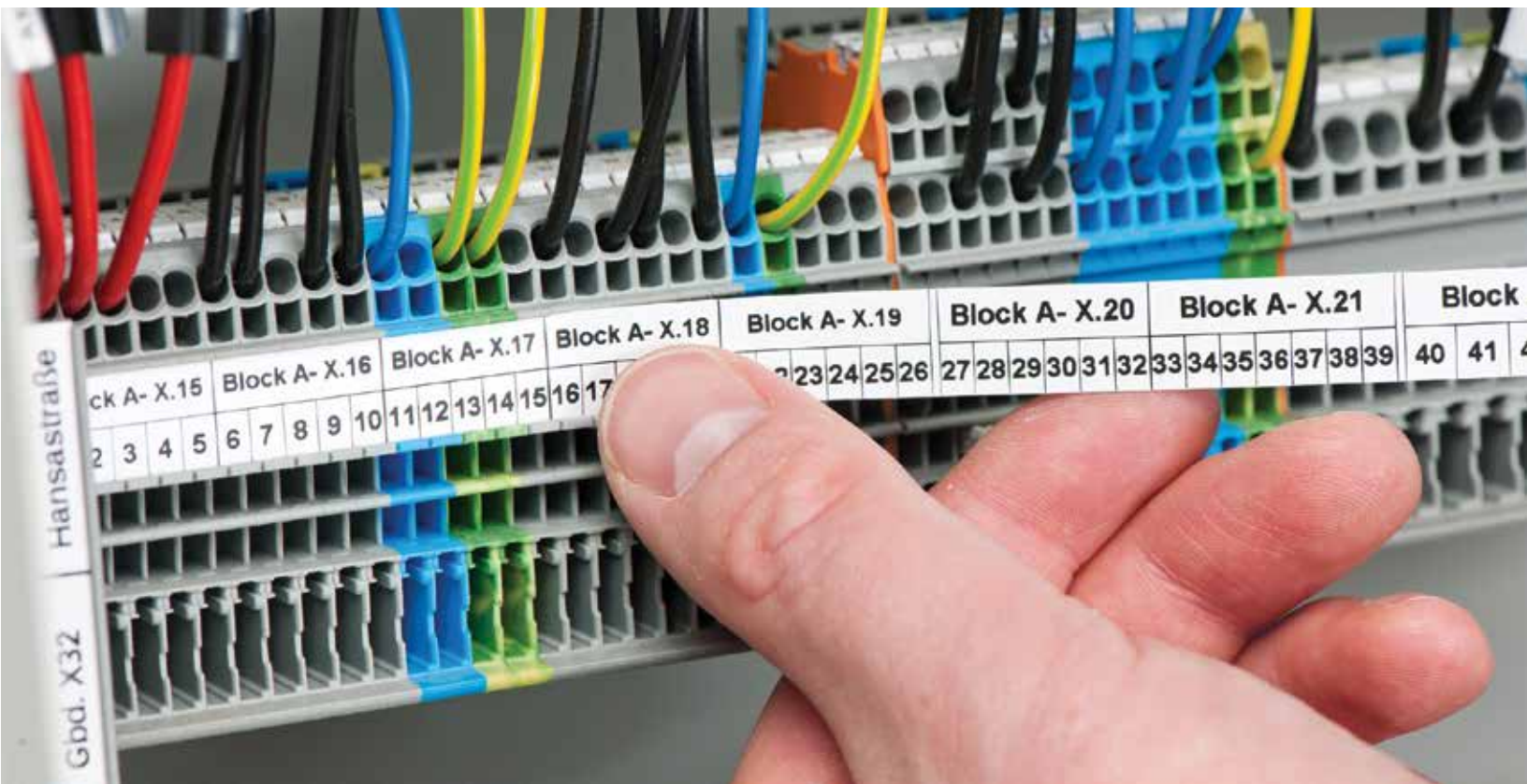

# CLEARLY MARK CONTROL CABINETS



## Terminal Block Marking

- WAGO terminal blocks can be labeled using two industry exclusive methods:
  - The continuous marker strip allows for fast, multi-line marking and can fit up to twelve characters of text per terminal block
  - WAGO WMB inline makers offer a single marking tag that fit the majority of WAGO components



## Cable and Conductor Marking

- Different versions available: marking sleeves, self-laminating labels, thread-on wire markers and heat shrink tubing
- Large variety for different wire sizes



## Device Marking

- Broad selection of label types for the entire cabinet including push-button markers and type plates
- Marking materials are available in a variety of colors and sizes

# TERMINAL BLOCK MARKING

Marking Strips



WMB Inline Markers on a Roll



Item No.	Width/Color	Pack. Unit
2009-110	11 mm, white	1 roll (50 m)
709-177	7.5 mm, translucent	1 roll (50 m)
709-178	7.5 mm, white	1 roll (50 m)
757-901/ 000-050	10 mm, white	1 roll (50 m)

Item No.	Description	Pack. Unit
2009-113	WMB Inline, white, 3.5 mm stretchable	1 roll (2,300 markers)
2009-114	WMB Inline, white, 4 mm stretchable	1 roll (2,000 markers)
2009-115	WMB Inline, white, 5 mm stretchable	1 roll (1,500 markers)
2009-145	Mini-WSB Inline, white, 5 mm stretchable	1 roll (1,700 markers)
2009-515	WMB Inline for Phoenix Contact terminal blocks, white, 5 mm stretchable	1 roll (900 markers) replaces UC-TM5 and ZB5 markers
2009-615	WMB Inline for Weidmüller terminal blocks, white, 5 mm stretchable	1 roll (1,200 markers) replaces WS 10/5 marker



# INLINE MARKERS AND ROLLERS

Description	Compatible with Series	Color (Marker)	Item No. (Marker)	Roller	Item No. (Roller)
Marking strips, cable and conductor markers, device labels		–	see Pages 8 and 12-15	 ● black	258-5006
WMB Inline, 3.5 mm stretchable 	Pages 10-11	○ white ● yellow ● red ● blue ● gray ● orange ● light green ● green ● violet	2009-113 2009-113/000-002 2009-113/000-005 2009-113/000-006 2009-113/000-007 2009-113/000-012 2009-113/000-017 2009-113/000-023 2009-113/000-024	 ● green	258-5007
WMB Inline, 4 mm stretchable 	Pages 10-11	○ white ● yellow ● red ● blue ● gray ● orange ● green ● violet	2009-114 2009-114/000-002 2009-114/000-005 2009-114/000-006 2009-114/000-007 2009-114/000-012 2009-114/000-017 2009-114/000-023 2009-114/000-024	 ● green	258-5007
WMB Inline, 5 mm stretchable 	Pages 10-11	○ white ● yellow ● red ● blue ● gray ● orange ● light green ● green ● violet	2009-115 2009-115/000-002 2009-115/000-005 2009-115/000-006 2009-115/000-007 2009-115/000-012 2009-115/000-017 2009-115/000-023 2009-115/000-024	 ● green	258-5007
Mini-WSB Inline, plain, 5 mm stretchable 	Pages 10-11	○ white ● yellow ● red ● blue ● orange ● green	2009-145 2009-145/000-002 2009-145/000-005 2009-145/000-006 2009-145/000-012 2009-145/000-023	 ● blue	258-5008
WMB Inline for Phoenix Contact terminal blocks, 5 mm stretchable, replaces UC-TM5 and ZB5 		○ white	2009-515	 ○ white	258-5009
WMB Inline for Weidmüller terminal blocks, 5 mm stretchable, replaces WS 10/5 		○ white	2009-615	 ● red	258-5010

# SELECTION MATRIX

## Marking Accessories and Appropriate Product Series

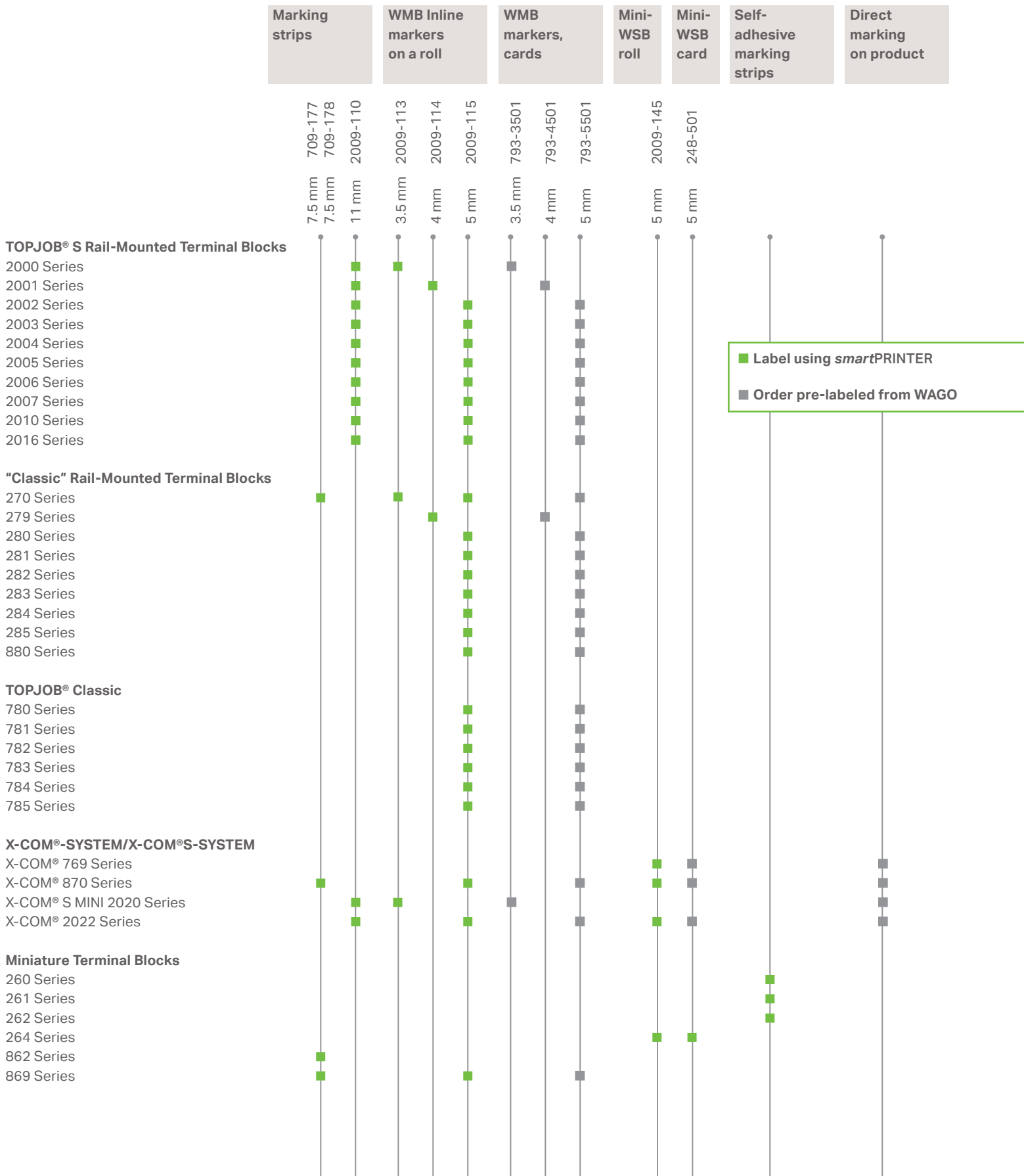

	Marking strips	WMB Inline markers on a roll	WMB markers, cards	Mini-WSB roll	Mini-WSB card	Self-adhesive marking strips	Direct marking on product
<b>Patchboard Systems</b>							
727 Series	7.5 mm 709-177 7.5 mm 709-178	3.5 mm 2009-113	3.5 mm 793-3501	5 mm 2009-145	5 mm 248-501		
<b>High-Current Terminal Blocks, POWER CAGE CLAMP</b>							
285 Series							
834 Series							
<b>PCB Terminal Blocks</b>							
745 Series							
746 Series							
831 Series							
218, 233, 234, 235, 236, 243, 250, 252, 253, 254, 255, 256, 257, 735, 736, 737, 738, 739, 740, 741, 742, 745, 746, 804, 805, 806, 816 Series							
<b>WAGO-I/O-SYSTEM</b>							
750 Series							
753 Series							
<b>INTERFACE Modules</b>							
788 Series							
857 Series							
858 Series							
859 Series							
<b>WINSTA®</b>							
770/771 Series							
890/891 Series							
<b>MULTI CONNECTION SYSTEM</b>							
231, 232, 713, 714, 721, 722, 733, 734, 831, 834, 2231, 2721 Series							
<b>picoMAX®</b>							
2091, 2092 Series							

# CABLE AND CONDUCTOR MARKING

## Marking Sleeves and Markers



Length: 12 mm

Item No.	Description and Color	Pack. Unit
211-812	<b>Marking sleeve</b> for 24 - 10 AWG wire diameter, transparent	1 bag (500 sleeves)
211-813	<b>Marking sleeve</b> for 8 - 2 AWG wire diameter, transparent	1 bag (500 sleeves)
211-811	<b>Marker for marking sleeve</b> 12 x 4 mm, white	1 roll (2,500 markers)

Length: 23 mm

Item No.	Description and Color	Pack. Unit
211-823	<b>Marking sleeve</b> for 24 - 10 AWG wire diameter, transparent	1 bag (500 sleeves)
211-824	<b>Marking sleeve</b> for 8 - 2 AWG wire diameter, transparent	1 bag (200 sleeves)
211-829	<b>Marking sleeve</b> Mounting via cable tie, transparent	1 bag (200 sleeves)
211-821	<b>Marker for marking sleeve</b> 23 x 4 mm, white	1 roll (2,500 markers)

## Cable Tie Markers



Item No.	Description and Color	Pack. Unit
211-835	<b>Cable tie marker</b> 25 x 20 mm (write-on surface: 25 x 10 mm), white	1 roll (500 markers)
211-836	<b>Cable tie marker</b> 100 x 15 mm, white	1 roll (800 markers)
211-836/ 000-002	<b>Cable tie marker</b> 100 x 15 mm, yellow	1 roll (800 markers)
807-0090/ 0101-0100	<b>Suitable cable ties</b>	1 bag (25 ties)

## Thread-On Wire Markers



Item No.	Description and Color	Pack. Unit
211-861	<b>Thread-on Markers</b> 5 x 10.5 mm write-on surface, 30-26 AWG, white	1 roll (1,000 markers)
211-862	<b>Thread-on Markers</b> 7 x 10.5 mm write-on surface, 24 - 18 AWG, white	1 roll (1,000 markers)
211-863	<b>Thread-on Markers</b> 10 x 17 mm write-on surface, 16 - 10 AWG, white	1 roll (1,000 markers)

## Self-Laminating Labels



Item No.	Description and Color	Pack. Unit
211-855	<b>Self-laminating labels</b> 9 x 18 mm write-on surface, white	1 roll (1,000 labels)
211-856	<b>Self-laminating labels</b> 15 x 12 mm write-on surface, white	1 roll (1,000 labels)
211-857	<b>Self-laminating labels</b> 18 x 44 mm write-on surface, white	1 roll (500 labels)

\*Requires alt. ink ribbon 258-5014

## Shrink Tubing (3:1 Shrink Ratio)



Item No.	Size	Recommended Diameter	Pack. Unit
51223870	1/8", White	24-18 AWG	1 roll (100 ft)
51227742	1/8", Yellow	24-18 AWG	1 roll (100 ft)
51223871	3/16", White	16 - 12 AWG	1 roll (100 ft)
51227743	3/16", Yellow	16 - 12 AWG	1 roll (100 ft)
51223872	1/4", White	12 - 8 AWG	1 roll (100 ft)
51227744	1/4", Yellow	12 - 8 AWG	1 roll (100 ft)
51273038	1/2", White	6-1/0 AWG	1 roll (100 ft)

\*Requires alt. ink ribbon 258-5014

# DEVICE MARKING

## Self-Adhesive Continuous Labels



Item No.	Description and Color	Pack. Unit
210-831	9 lines, 2.3 mm wide, white	1 roll (25 m)
210-832	9 lines, 3 mm wide, white	1 roll (25 m)
210-834	5 lines, 5 mm wide, white	1 roll (25 m)
210-833	5 lines, 6 mm wide, white	1 roll (25 m)

## Self-Adhesive Marking Strips

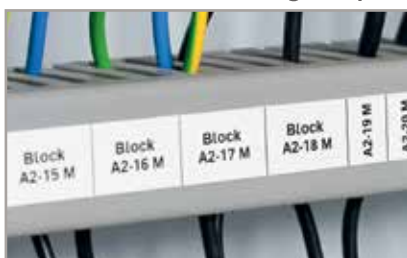

Item No.	Description and Color	Pack. Unit
210-702	15 mm wide, white	1 roll (50 m)
210-870	10 mm wide, white	1 roll (20 m)
210-871	10 mm wide, silver	1 roll (20 m)
210-872	20 mm wide, white	1 roll (20 m)
210-873	20 mm wide, silver	1 roll (20 m)
210-874	30 mm wide, white	1 roll (20 m)
210-875	30 mm wide, silver	1 roll (20 m)
210-876	46 mm wide, white	1 roll (20 m)
210-876/000-002	46 mm wide, yellow	1 roll (20 m)
210-877	46 mm wide, silver	1 roll (20 m)

## Self-Adhesive Polyester Labels



Item No.	Description and Color	Pack. Unit
210-805	6 x 15 mm, white	1 roll (3,000 labels)
210-805/000-002	6 x 15 mm, yellow	1 roll (3,000 labels)
210-806	9 x 15 mm, white	1 roll (3,000 labels)
210-806/000-002	9 x 15 mm, yellow	1 roll (3,000 labels)
210-807	8 x 20 mm, white	1 roll (3,000 labels)
210-807/000-002	8 x 20 mm, yellow	1 roll (3,000 labels)
210-808	9.5 x 25 mm, white	1 roll (1,500 labels)
210-810	5 x 35 mm, white	1 roll (1,500 labels)

## Self-Adhesive Fabric Labels



Item No.	Description and Color	Pack. Unit
210-811	7 x 20 mm, 1 line, white	1 roll (3,000 labels)
210-811/000-002	7 x 20 mm, 1 lines, yellow	1 roll (3,000 labels)

## Push-Button Markers



Item No. (Push-Button Marker)	Size	Pack. Unit	Color/Other	Accessories for Push-Button Markers	Pack. Unit
210-850*	26.5 x 18.0 mm	1 roll (1,000 markers)	silver, detachable adhesive	210-851 Cover, transparent	100 covers
210-856**	27.5 x 17.5 mm	1 roll (1,000 markers)	silver, detachable adhesive	210-857 Cover, transparent	100 covers
210-858**	22.0 x 22.0 mm	1 roll (1,000 markers)	silver, permanent adhesive	210-859 Cover, transparent	100 covers
210-860**	27.0 x 27.0 mm	1 roll (1,000 markers)	silver, permanent adhesive	210-861 Cover, transparent	100 covers
210-862**	27.0 x 12.5 mm	1 roll (1,000 markers)	silver, permanent adhesive	210-863 Cover, transparent	100 covers
210-852	27.0 x 19.0 mm	1 roll (350 markers)	silver, permanent adhesive	210-853 Frame for 22.5 mm push-buttons, black	100 frames
210-855	27.0 x 18.0 mm	1 roll (350 markers)	silver, permanent adhesive	-	-
210-854	28.0 x 28.0 mm	1 roll (500 markers)	silver, permanent adhesive	-	-
210-847	22.0 x 22.0 mm	1 roll (300 markers)	silver, permanent adhesive	-	-
210-848	27.0 x 27.0 mm	1 roll (250 markers)	silver, permanent adhesive	-	-

\* For Eaton      \*\* For Siemens

## Type Plates



Item No.	Description and Color	Pack. Unit
210-801	33 x 70 mm, white	1 roll (500 plates)
210-802	33 x 70 mm, silver	1 roll (500 plates)
210-803	44 x 99 mm, white	1 roll (500 plates)
210-804	44 x 99 mm, silver	1 roll (500 plates)
210-812	25 x 50 mm, silver	1 roll (500 plates)

## Void/Tamper-Proof Label



Item No.	Description and Color	Pack. Unit
60328726	38 x 76 mm, silver	1 roll (500 labels)

**WAGO Corporation**  
N120 W19129 Freistadt Road  
Germantown, Wisconsin 53022  
Telephone: 800 / DIN Rail (346-7245)  
Fax: 262 / 255-3232  
info.us@wago.com  
www.wago.us

**Canada**  
WAGO Corporation  
Tel. 800/DIN Rail (346-7245)  
Fax 262/255-3232  
www.wago.ca

**Mexico**  
WAGO Corporation  
Queretaro  
Tel. 001/800/309/5975  
+ 52/442/221/5946  
Fax + 52/442/221/5063  
www.wago.mx

WAGO is a registered trademark of WAGO Verwaltungsgesellschaft mbH.

"Copyright – WAGO Kontakttechnik GmbH & Co. KG – all rights reserved. The content and structure of the WAGO Websites, catalogs, videos, and other WAGO media are subject to copyright. The dissemination or changing of the content of these pages and videos is not permitted. Furthermore, the content may neither be copied nor made available to third parties for commercial purposes. Also subject to copyright are the images and videos that were made available to WAGO Kontakttechnik GmbH & Co. KG by third parties."